



FST

SUCTION FILTER WITH SEALED FLANGE MOUNTING

SERIES 10

Q max (see performances table)

OPERATING PRINCIPLE

Hexagonal head tie rod starting the exclusion valve

Filter element

Check valve to allow replacement of the filter element without emptying the tank

- FST filters are designed for sealed flange mounting. They are assembled directly on to the hydraulic power unit.
- They are aimed at protecting the pump from any possible gross contamination present inside the tank.
- The filter element is made of a metallic strainer with a 90 µm filtration degree, which grants a good pump protection without compromising the correct fluid flow. It can be easily replaced without emptying the tank. See paragraph 6 for its identification code.
- The filters are designed with a SAE flange port with the exception of the smallest size, which uses a BSP threaded port.
- All the FST filters are designed to incorporate an electric or visual clogging indicator, to be ordered separately (see paragraph 5).

PERFORMANCES

Filter code	port dimensions		Mass [kg]	Rated flow (indicative) [l/min]	Rated filtration degree [µm]
	BSP	SAE flange			
FST-TB114	1 1/4"	-	1,6	70	90
FST-FS212	-	2 1/2"	3,0	100	
FST-FS300	-	3"	13,0	200	
FST-FS400	-	4"	16,0	300	

NOTE 1: the flow rates stated in the table correspond to a 0.02 bar pressure drop measured with mineral oil of viscosity 36 cSt at 50°C.
As for a different viscosity range, see NOTE 2 - paragraph 2.2.

Collapsing differential pressure of the filter element	bar	1,0
Ambient temperature range	°C	-25 / +50
Fluid temperature range	°C	-25 / +110
Fluid viscosity range	cSt	10 + 400

HYDRAULIC SYMBOL

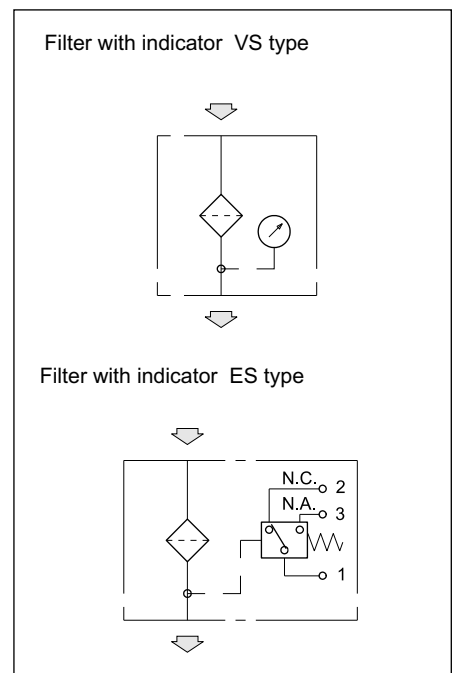

1 - IDENTIFICATION CODE

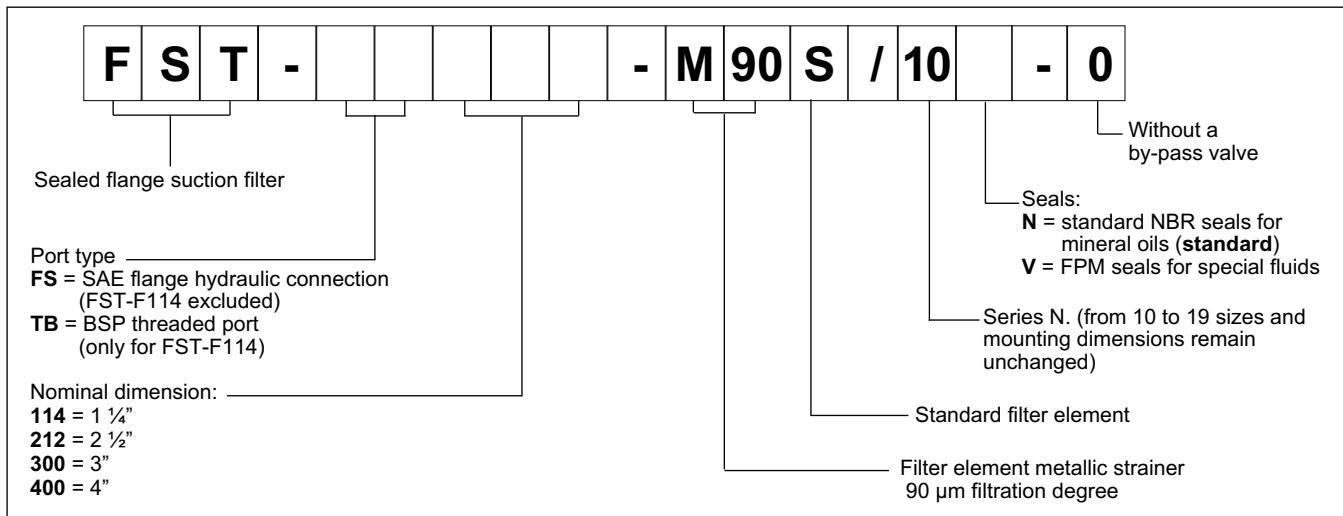

2 - CHARACTERISTIC CURVES

(values measured with viscosity of 36 cSt at 50°C)

2.1 - Pressure drops through the filter body

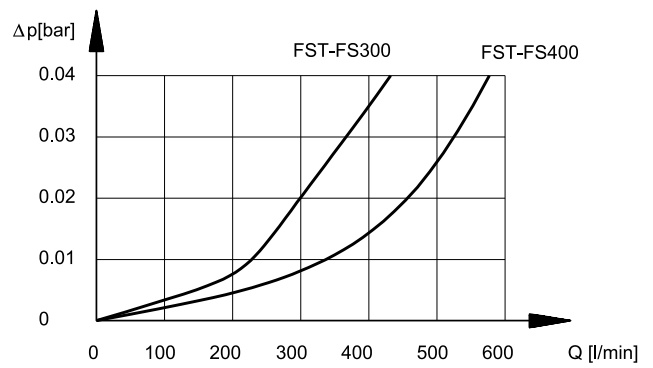
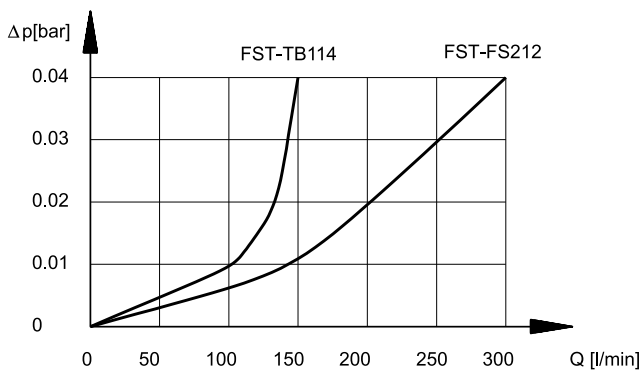

2.2 - Pressure drops through the FSTE filter element

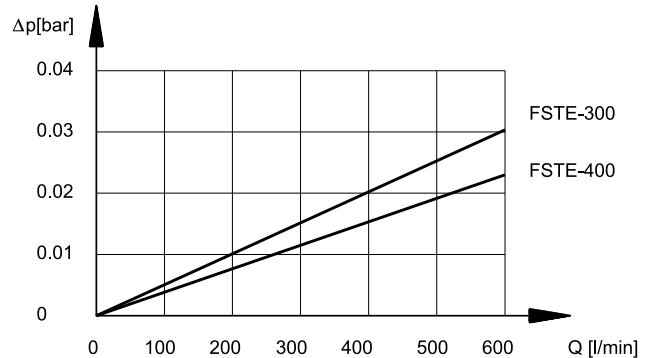
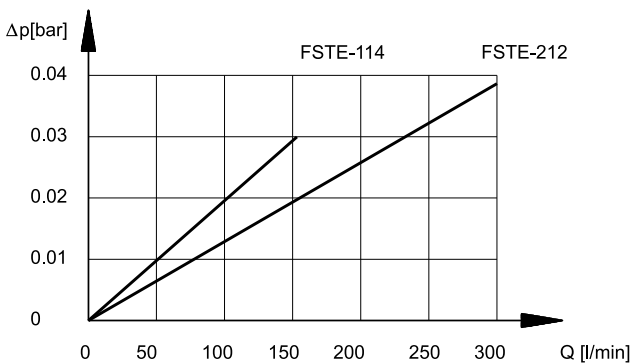

NOTE 2: the filter size has to be selected so that with the nominal flow rate the pressure drop is lower than 0,02 bar.

The total pressure drop through the filter is given by adding the body pressure drop values to those of the filter element.

As for fluids whose viscosity degree at a specific operating pressure is different from 36 cSt, the filter total pressure drop has to be changed according to the following ratio:

$$\text{total } \Delta p \text{ value} = \text{body } \Delta p \text{ value} + (\text{real } \Delta p \text{ value of the filter element} \times \text{real viscosity value (cSt)} / 36)$$

$$\text{real } \Delta p \text{ value of the filter element} = \text{value obtainable through the diagrams in paragraph 2.2}$$

Such ratio is valid for a viscosity value up to 200 cSt.

For a higher viscosity please consult our technical department.

3 - HYDRAULIC FLUIDS

Use mineral oil-based hydraulic fluids HL or HM type, according to ISO 6743-4. For these fluids, use NBR seals. For fluids HFDR type (phosphate esters) use FPM seals (code V). For the use of other kinds of fluid such as HFA, HFB, HFC, please consult our technical department. Using fluids at temperatures higher than 80 °C causes a faster degradation of the fluid and of the seals characteristics. The fluid must be preserved in its physical and chemical characteristics.

4 - OVERALL AND MOUNTING DIMENSIONS

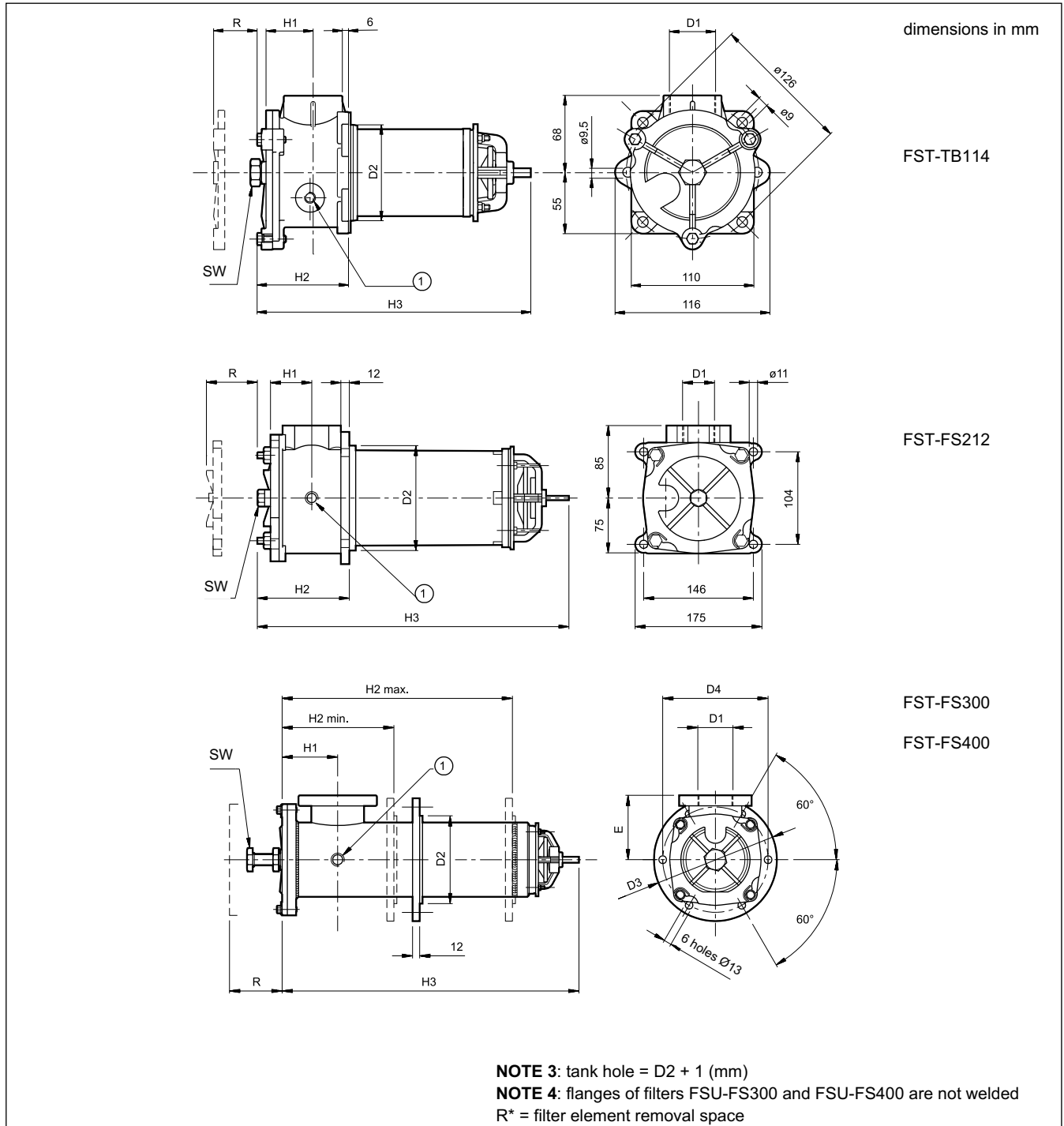

Filter code	D1	D2 NOTE 3	D3	D4	E	H1	H2 NOTE 4	H3	R*	Ch
FST-TB114	1 1/4" BSP	86	-	-	-	42	80	275	250	22
FST-FS212	2 1/2" SAE	130	-	-	-	66	120	322	300	22
FST-FS300	3" SAE	150	210	180	110	95	174+355	480	500	32
FST-FS400	4" SAE	180	242	210	120	122	250+405	470	500	32

1 Clogging indicator port:
1/8" BSP usually plugged

5 - CLOGGING INDICATORS

The filters are designed to incorporate clogging indicators, which have to be ordered separately.

5.1 - Visual indicator for suction filters

Identification code: **VS/10**

This indicator is a vacuum gauge sensitive to the suction depression.

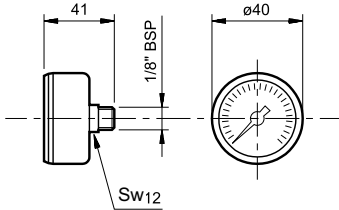

The indicator is supplied with a 0 ÷ -1 relative bar graduated scale and with a three-colour reading scale, which informs you about the clogging condition of

the filter element:

GREEN: efficient filter element (0 / -0.15 bar)

YELLOW: the filter element is wearing out (-0.15 / -0.25 bar)

RED: the filter element has to be replaced (> -0.25 bar)

5.2 - Electric indicator for suction filters

Identification code: **ES/10**

This indicator is a vacuum gauge sensitive to the suction depression, which operates by switching an electric contact when the filter element has reached the clogging limit.

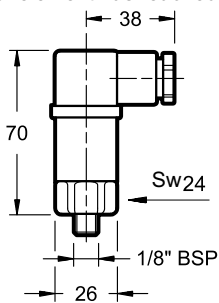

The contact can be wired in an open or closed condition (see the hydraulic symbol).

TECHNICAL SPECIFICATIONS

Operating pressure	bar	- 0,2
AC power supply		
Max. operating voltage	VAC	250 50/60 Hz
Max. load on the contacts (inductive or resistive) with V at 125 VAC with V at 250 VAC	A	3 0,5
DC power supply		
Max. operating voltage	VDC	30
Max. load on the contacts resistive inductive	A	3 1
Electric connector	DIN 43650	
Class of protection according to CEI EN 60529 (atmospheric agents)	IP65	
Atex classification	3 GD EEx e T6	

6 - FILTER ELEMENTS

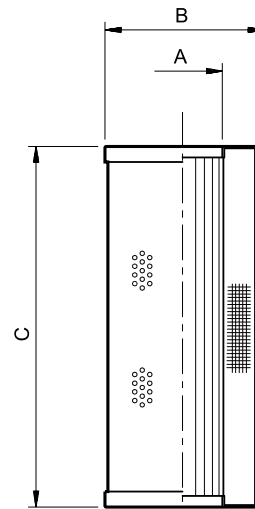

Filter element code	ØA	ØB	C	Average filter surface [cm ²]
FSTE - 114	29,5	70	163	1600
FSTE - 212	65	99	198	1845
FSTE - 300	65	99	375	3545
FSTE - 400	93	136	375	5065

FILTER ELEMENT IDENTIFICATION CODE

F S T E - - M 90 S / 10

Filter element for a FST filter

Nominal dimensions
114 = 1 1/4" **300 = 3"**
212 = 2 1/2" **400 = 4"**

Filter element metallic strainer 90 µm filtration degree

Standard filter element

Series N. (from 10 to 19 sizes and mounting dimensions remain unchanged)