



FPM

MEDIUM PRESSURE FILTER FOR LINE MOUNTING

SERIES 10

p max **210** bar
Q max (see table of performances)

OPERATING PRINCIPLE

- The FPM filters are designed to be line-mounted with BSP threaded ports for hydraulic connections. Threaded holes are machined on the head for possible filter bracket fixing .
- The replacement of the filter element can be easily carried out by using a normal hexagon spanner to unscrew the bowl of the filter, which has a suitably shaped end.
- FPM filters are designed to be installed on medium pressure lines up to 210 bar; the filter elements are made of high efficiency filtering materials and are available with three different filtration degrees:
F05 = 5 µm absolute ($\beta_5 > 100$ - ISO 4401:1999 class 17/15/12)
F10 = 10 µm absolute ($\beta_{10} > 100$ - ISO 4401:1999 class 18/16/13)
F25 = 25 µm absolute ($\beta_{25} > 100$ - ISO 4401:1999 class 19/17/14)
- The filters are always supplied with a by-pass valve.
- The filter elements are available in the standard version (S) or in the long-lasting version (L) is able to hold high quantities of contamination material. For all filter elements the collapsing differential pressure is 20 bar.
- All the FPM filters are designed to incorporate a visual-differential or a visual-electric clogging indicator to be ordered separately (see paragraph 5).

PERFORMANCES

Filter code	BSP port dimensions	Mass [Kg]		Rated flow (indicative) [l/min]					
		type S	type L	F05S	F05L	F10S	F10L	F25S	F25L
FPM-TB012	1/2"	1,5	2,0	25	40	35	50	45	60
FPM-TB034	3/4"			35	50	50	65	65	80
FPM-TB100	1"			40	60	60	85	85	100

NOTE 1: the flow rates stated in the table correspond to a 0.8 bar pressure drop measured with mineral oil of viscosity 36 cSt at 50°C.
As for a different viscosity range, see NOTE 2 - par. 2.2.

Maximum operating pressure	bar	210
Collapsing differential pressure of the filter element	bar	20
Differential pressure for the opening of the by-pass valve ($\pm 10\%$)	bar	6
Ambient temperature range	°C	-25 / +50
Fluid temperature range	°C	-25 / +110
Fluid viscosity range	cSt	10 ÷ 400

HYDRAULIC SYMBOL

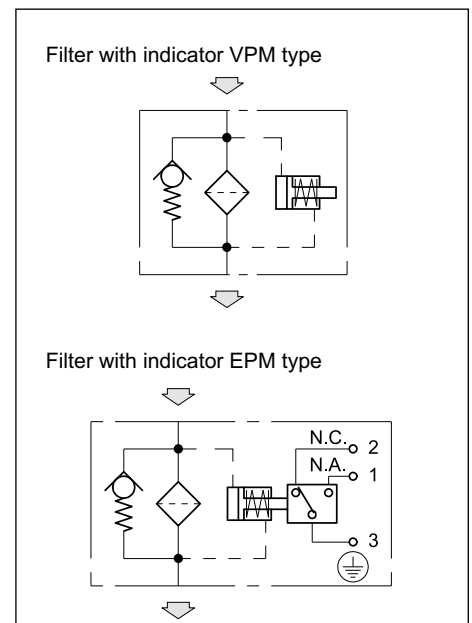

1 - IDENTIFICATION CODE

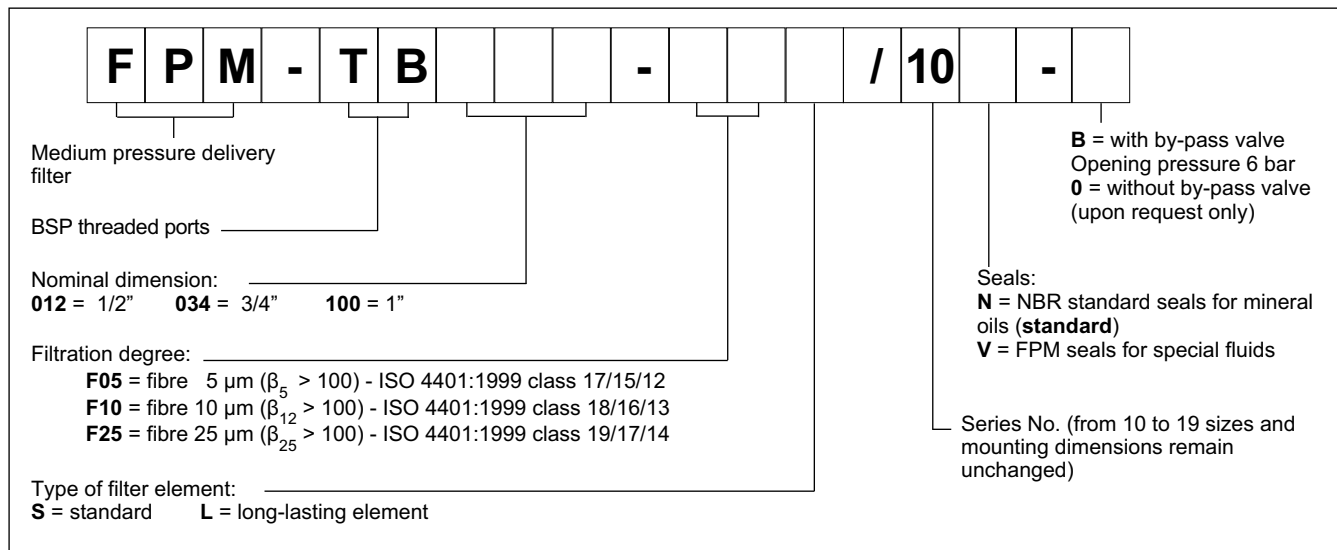

2 - CHARACTERISTIC CURVES

(values measured with viscosity of 36 cSt at 50°C)

2.1 - Pressure drops through the filter body

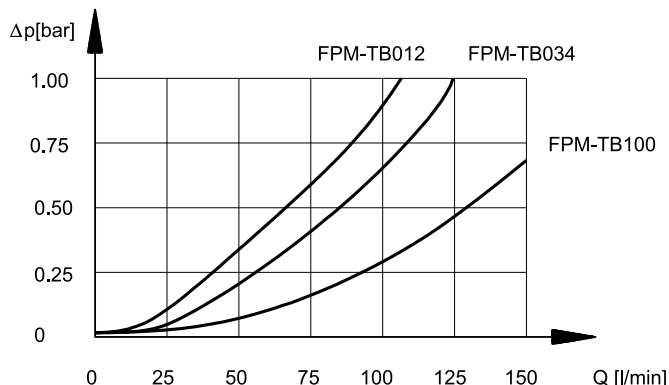

2.2 - Pressure drops through FPME filter element

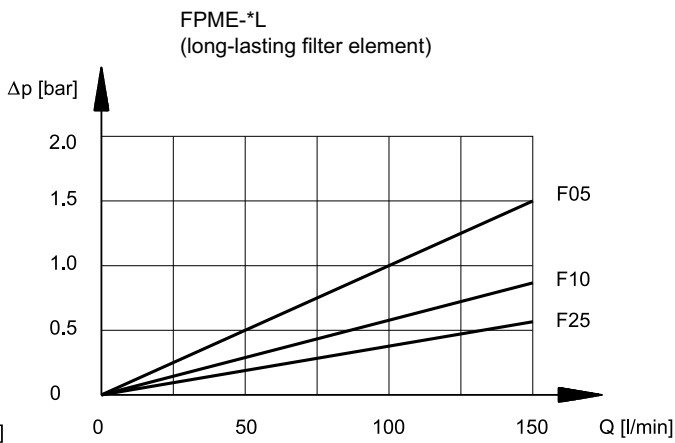
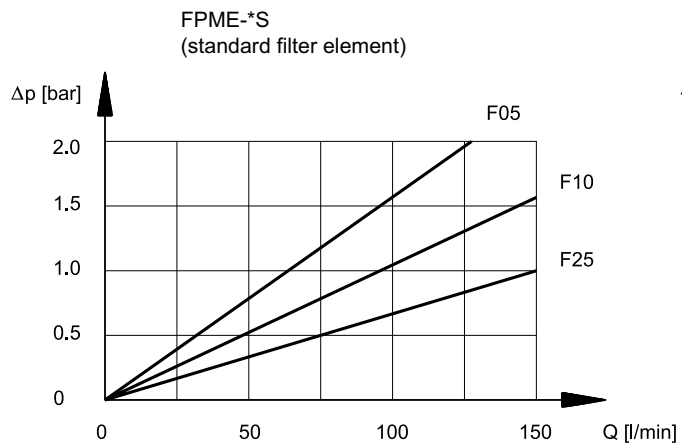

NOTE 2: The filter size has to be selected so that with the nominal flow rate the pressure drop is lower than 0.8 bar.

The total pressure drop through the filter is given by adding the body pressure drop values to those of the filter element. As for fluids whose viscosity degree at a specific operating pressure is different from 36 cSt, the filter total pressure drop has to be changed according to the following ratio:

$$\text{total } \Delta p \text{ value} = \text{body } \Delta p \text{ value} + (\text{real } \Delta p \text{ value of the filter element} \times \text{real viscosity value (cSt)} / 36)$$

$$\text{real } \Delta p \text{ value of the filter element} = \text{value obtainable through the diagrams in paragraph 2.2}$$

Such ratio is valid for a viscosity value up to 200 cSt. For a higher viscosity please consult our technical department.

2.3 - Pressure drops through by-pass valve

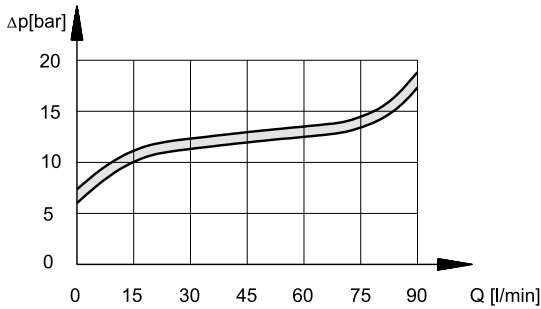

3 - HYDRAULIC FLUIDS

Use mineral oil-based hydraulic fluids HL or HM type, according to ISO 6743-4. For these fluids, use NBR seals. For fluids HFDR type (phosphate esters) use FPM seals (code V). For the use of other kinds of fluid such as HFA, HFB, HFC, please consult our technical department. Using fluids at temperatures higher than 80 °C causes a faster degradation of the fluid and of the seals characteristics.

The fluid must be preserved in its physical and chemical characteristics.

4 - OVERALL AND MOUNTING DIMENSIONS

dimensions in mm

1	Clogging indicator port: M20x1,5
---	----------------------------------

R* = Filter element removal space

Filter code	D1	H1	H2	R*
FPM-TB012-*S	1/2	20	11	10
FPM-TB034-*S	3/4	20	11	10
FPM-TB100-*S	1"	20	11	10
FPM-TB012-*L	1/2	29	19	10
FPM-TB034-*L	3/4	29	19	10
FPM-TB100-*L	1"	29	19	10

5 - CLOGGING INDICATORS

The filters are all designed to incorporate clogging indicators, which have to be ordered separately

5.1 - Visual indicator for medium pressure delivery filters

Identification code: **VPM/10**

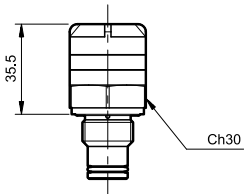

This indicator measures the differential pressure between the filter input and output.

The indicator is supplied with coloured bands, which informs you about the clogging condition of the filter element:

WHITE: efficient filter element
 $\Delta p < 5 \text{ bar } (\pm 10\%)$

RED: the filter element has to be replaced
 $\Delta p > 5 \text{ bar } (\pm 10\%)$

5.2 - Electric-visual indicator for delivery filters

Identification code: **EPM/10**

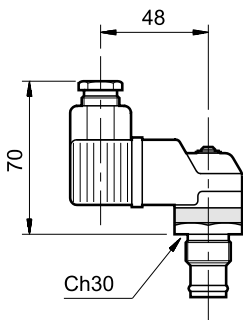

This indicator, apart from giving a visual indication, for example the VPM model, operates by switching an electric contact when the filter element has reached the clogging limit.

The contact can be wired in an open or closed condition (see the hydraulic symbol).

TECHNICAL SPECIFICATIONS

Differential operating pressure	bar	5
AC power supply		
Max. operating voltage	VAC	250 50/60 Hz
Max. load on the contacts (inductive or resistive)	A	5
DC power supply		
Max. operating voltage	VDC	125
Max. load on the contacts (with V at 30-50-75-125 VDC) resistive inductive	A	2 - 0,5 - 0,25 - 0,2 2 - 0,5 - 0,25 - 0,03
Electric connector	EN 175301-803 (ex DIN 43650)	
Class of protection according to CEI EN 60529 (atmospheric agents)	IP65	

6 - FILTER ELEMENTS

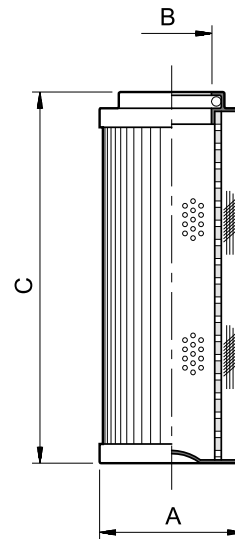

filter element code	ØA	ØB	C	Average filtering surface [cm ²]
FPME - *S	52	23,5	115	975
FPME - *L	52	23,5	210	1830

FILTER ELEMENT IDENTIFICATION CODE

F P M E - / 10

Filter element for FPM filters

Filtration degree:
F05 = fibre 5 µm
F10 = fibre 10 µm
F25 = fibre 25 µm

Filter element type:
S = standard
L = long-lasting

Series No. (from 10 to 19 sizes and mounting dimensions remain unchanged)

N = NBR seals for mineral oils (**standard**)
V = FPM seals for special fluids (upon request)