

EWM-A-SV

ANALOGUE AMPLIFIER CARD SERVOVALVE CONTROL SERIES 10

**RAIL MOUNTING TYPE:
DIN EN 50022**

OPERATING PRINCIPLE

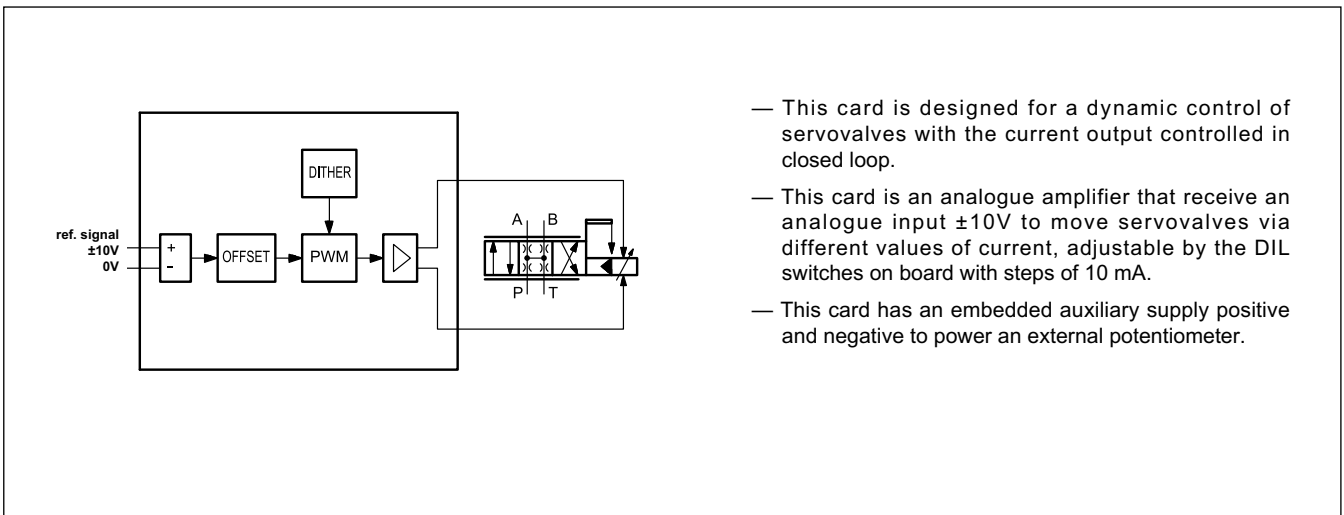

TECHNICAL CHARACTERISTICS

Power supply	V DC	18 \pm 30 ripple included
Current consumption	mA	100 + solenoid current consumption (max 300 mA)
Command position value	V	± 10 ($R_1 = 100$ k Ω)
Output current	mA	10 to 200 (DIL switches internal selection) ($R_1 = 33$ Ω for max I)
Dither Amplitude	Hz %	250 / 100 (DIL switch internal selection S6) 0..15 (5% pre-adjusted) of current
Offset	%	± 10
Auxiliary supply	V mA	± 10 10
Electromagnetic compatibility (EMC): according to 2014/30/EU standards		Emissions EN 61000-6-4 Immunity EN 61000-6-2
Housing material		thermoplastic polyamide PA6.6 -combustibility class V0 (UL94)
Housing dimensions	mm	120(d) x 99(h) x 23(w)
Connector		4x4 poles screw terminals - PE direct via DIN rail
Operating temperature range	$^{\circ}C$	0 / 50
Protection degree		IP 20

1 - IDENTIFICATION CODE

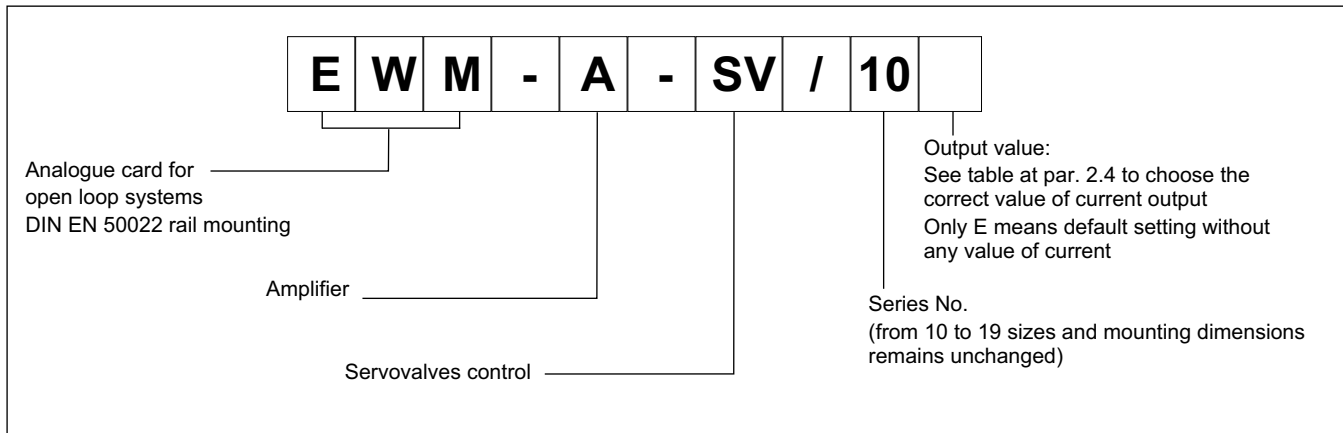

The power amplifier is controlled by an analogue input ± 10 Volt.

The output current is closed loop controlled and therefore independent from the supply voltage and the solenoid resistance.

The diagram below shows as resistance changes in function of output to keep constant current ($I = 200$ mA)

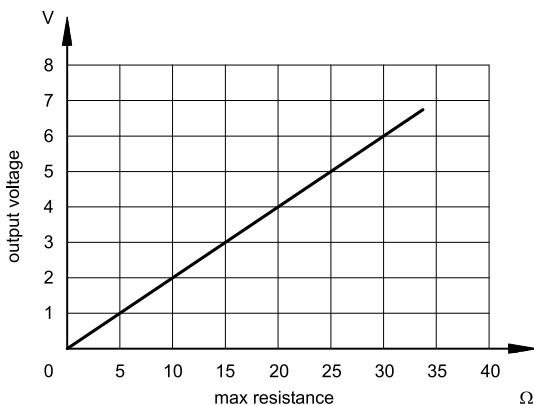

2 - FUNCTIONAL SPECIFICATIONS

2.1 - Power supply

This card is designed for 12 to 30 V DC (typical 24 V) of a power supply. This power supply must correspond to the actual EMC standards.

All inductivity at the same power supply (relays, valves) must be provided with an over voltage protection (varistors, freewheeling diodes).

It is recommended to use a regulated power supply (linear or switching mode).

2.2 - Electrical protections

All inputs and outputs are protected against overvoltage and have filters.

2.3 - Reference signal

The card accepts an analogue input signal. The command value can be ± 10 V ($R_I = 100$ k Ω).

2.4 - Output values

The card has different output values in current between 10 mA to 200 mA. It is necessary to open the case and inside the card there are internal DIL switches (S1...S5) for the adjustments:

	Current	S1	S2	S3	S4	S5
E	0 mA	OFF	OFF	OFF	OFF	OFF
E10	10 mA	ON	OFF	OFF	OFF	OFF
E20	20 mA	OFF	ON	OFF	OFF	OFF
E30	30 mA	ON	ON	OFF	OFF	OFF
E40	40 mA	OFF	OFF	ON	OFF	OFF
E50	50 mA	ON	OFF	ON	OFF	OFF
E60	60 mA	OFF	ON	ON	OFF	OFF
E70	70 mA	ON	ON	ON	OFF	OFF
E80	80 mA	OFF	OFF	OFF	ON	OFF
E90	90 mA	ON	OFF	OFF	ON	OFF
E100	100 mA	OFF	ON	OFF	ON	OFF
E110	110 mA	ON	ON	OFF	ON	OFF
E120	120 mA	OFF	OFF	ON	ON	OFF
E130	130 mA	ON	OFF	ON	ON	OFF
E140	140 mA	OFF	ON	ON	ON	OFF
E150	150 mA	ON	ON	ON	ON	OFF
E160	160 mA	OFF	OFF	OFF	OFF	ON
E170	170 mA	ON	OFF	OFF	OFF	ON
E180	180 mA	OFF	ON	OFF	OFF	ON
E190	190 mA	ON	ON	OFF	OFF	ON
E200	200 mA	OFF	OFF	ON	OFF	ON

2.5 - Digital Output

The digital output is the POWER ON signal, displayed from the green led.

3 - LED FUNCTIONS

There is only one green led.

GREEN: Shows if the card is ready.

- ON - The card is supplied
- OFF - No power supply

4 - ADJUSTMENTS

For these cards it is possible the regulation of offset and dither amplitude. It is necessary to open the case and inside the card there are offset and dither potentiometers for the adjustments.

4.1 - Offset

With this potentiometer it is possible to adjust the zero point. This module is pre-adjusted, often no further adjustment is necessary.

4.2 - Dither

With this potentiometer it is possible to adjust the dither amplitude. The dither amplitude have to be optimised to get best valve or drive performance. Dither adjustment will reduce hysteresis.

The frequency range has to be selected by internal DIL switch S6:

S6	Dither
ON	250 Hz
OFF	100 Hz

5 - INSTALLATION

The card is designed for rail mounting type DIN EN 50022.

The wiring connections are on the terminal strip located on the bottom of the electronic control unit. It is recommended to use cable sections of 0.75 mm², up to 20 m length and of 1.00 mm² up to 40m length, for power supply and solenoid connections on versions it is recommended to use cables with a screened sheath connected to earth only on the card side.

NOTE: To observe EMC requirements it is important that the control unit electrical connection is in strict compliance with the wiring diagram.

As a general rule, the valve and the electronic unit connection wires must be kept as far as possible from interference sources (e.g. power wires, electric motors, inverters and electrical switches).

A complete protection of the connection wires can be requested in environments with critical electromagnetic interferences.

6 - WIRING DIAGRAM

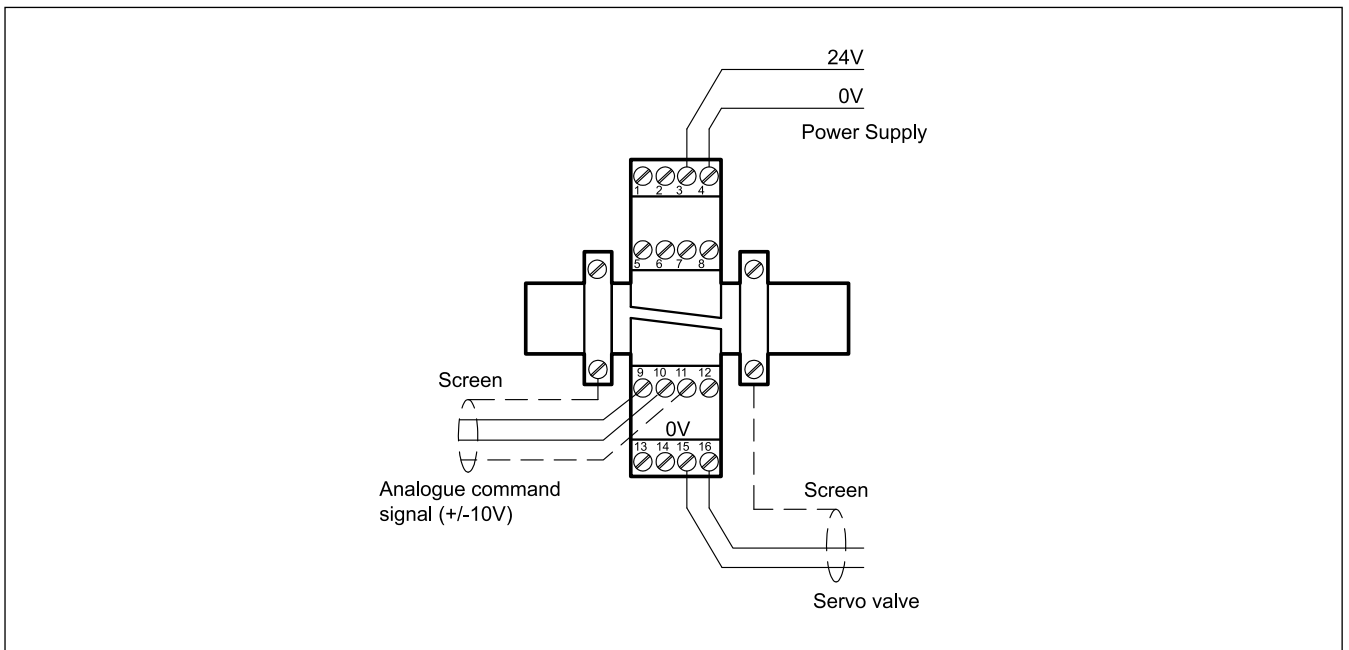

ANALOGUE INPUT AND OUTPUT

PIN 15/16 PWM outputs for coils control.

PIN 5/6 Auxiliary supply +10V (PIN 6) and -10V (PIN 5) to power external potentiometer.

PIN 9/10 Reference signal ±10V



7 - CARD BLOCK DIAGRAM

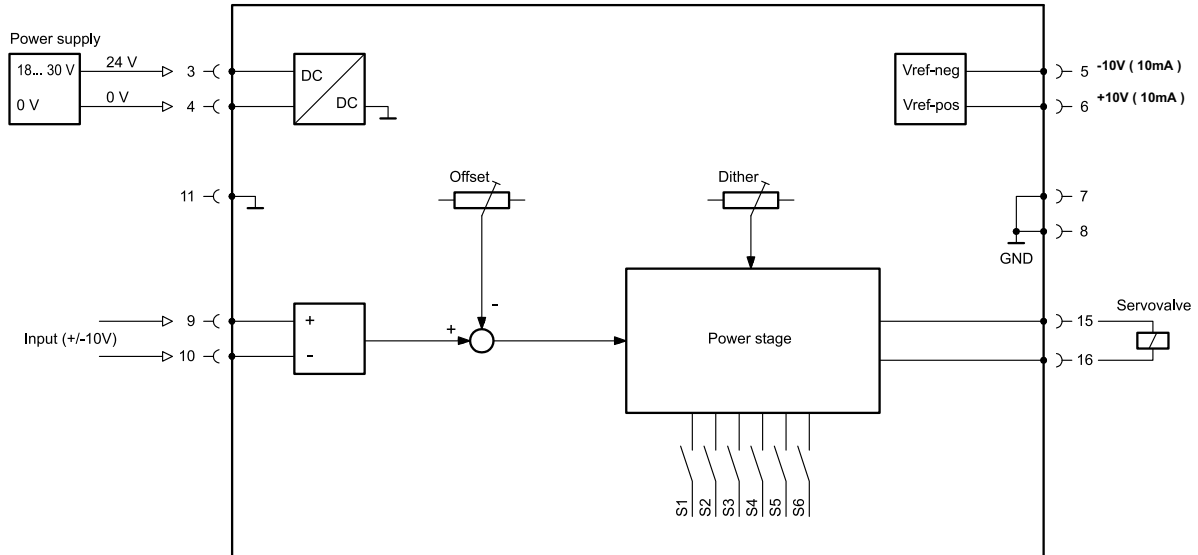

AVAILABLE COMMAND SIGNALS

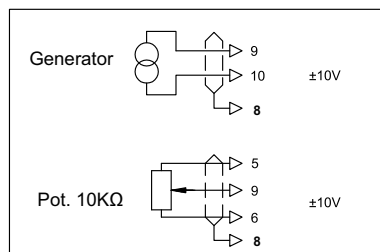

NOTE: with the potentiometer as reference signal it is necessary to connect PIN 10 with PIN 11.

8 - OVERALL AND MOUNTING DIMENSIONS

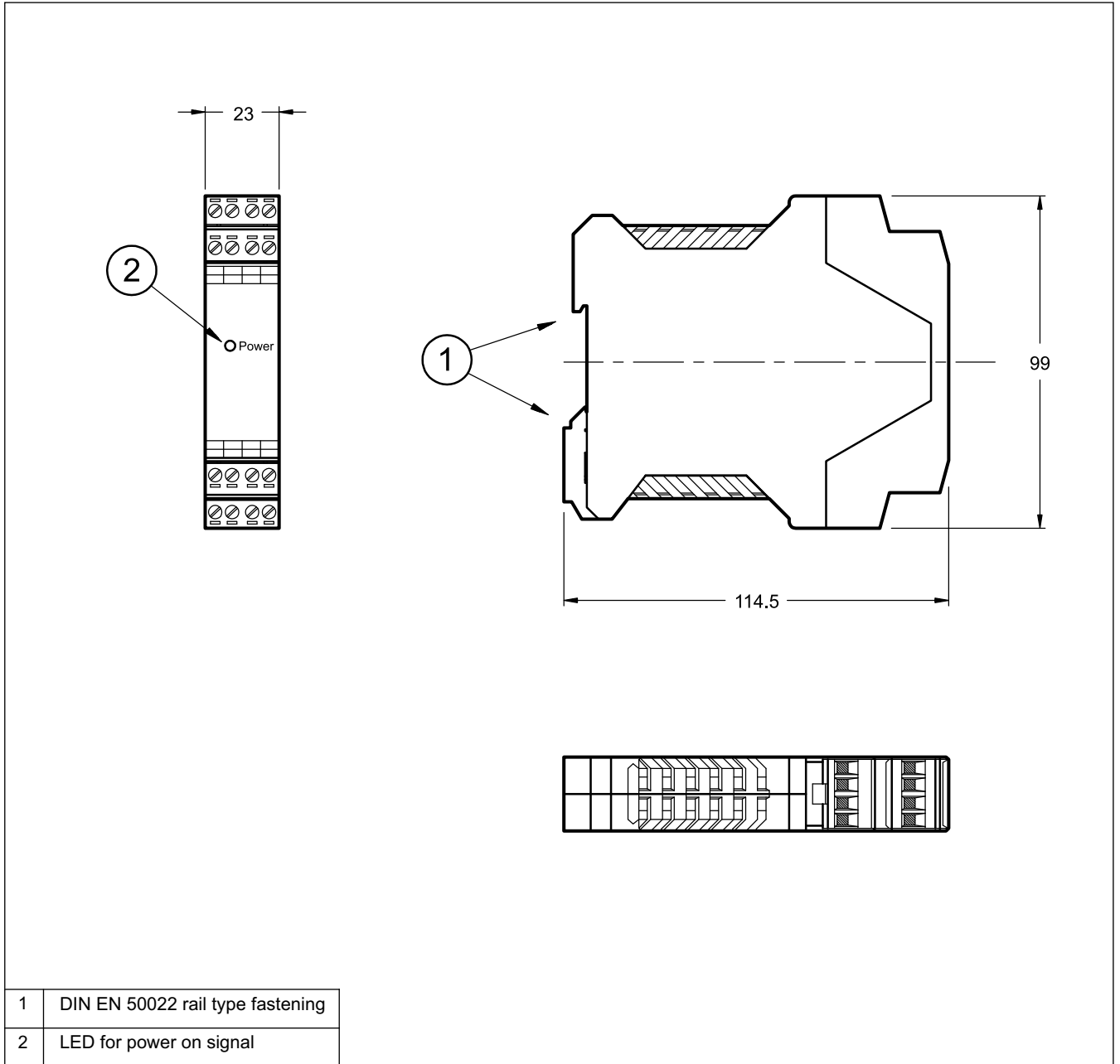



EWM-A-SV

SERIES 10



DIPLOMATIC MS S.p.A.

via M. Re Depolini 24 • 20015 PARABIAGO (MI) • ITALY
tel. +39 0331.895.111 • www.diplomatic.com • e-mail: sales.exp@diplomatic.com